

Important Safety Instructions:

- These instructions are provided for your safety. It is very important that they are read carefully and completely before beginning the assembly and installation of this lighting fixture.
- This portable luminaire has a polarized plug (one blade is wider than the other) as a safety feature to reduce the risk of electric shock. This plug will fit in a polarized outlet only one way. If the plug does not fit fully in the outlet, reverse the plug. If it still does not fit, contact a qualified electrician. Never use with an extension cord unless plug can be fully inserted. Do not alter the plug. Do not attempt to defeat this safety feature.
- For your safety and convenience, it is strongly recommended that two people install the lighting fixture.
- This fixture has been rated for up to one (1) **60-watt maximum TYPE A standard incandescent light bulbs(not included) or one (1) 13-Watt compact fluorescent light bulb (not included) or one (1) 9-watt SBLED bulb (Included)**. To avoid the risk of fire, do not exceed the recommended wattage.
- This lamp is meant for indoor use.
- **Save these instructions.**

WARNING:

- **To reduce the risk of fire, electrical shock or personal injury, always turn off and unplug the light fixture and allow it to cool prior to replacing the light bulb.**
- **Do not touch bulb when fixture is turned on. Do not look directly at lit bulb.**
- **Keep flammable materials away from lit bulb.**

Pre-assembly:

- Remove all parts and hardware from box along with any plastic protective packaging.
- Do not discard any contents until after assembly is complete to avoid accidentally discarding small parts or hardware.

Parts Included:



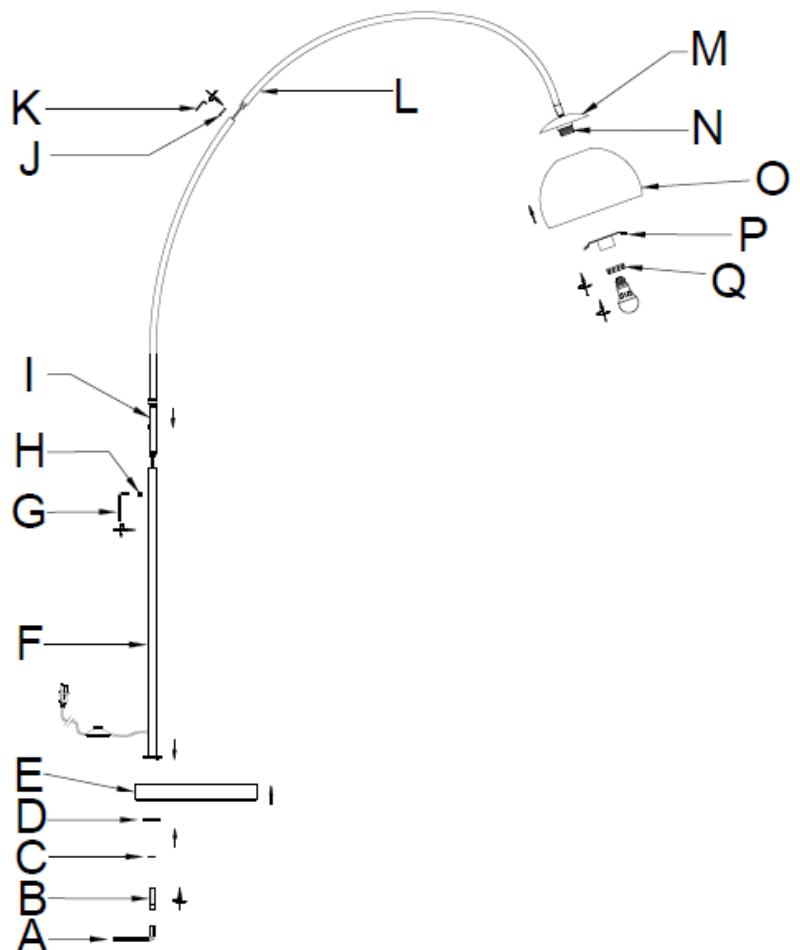





- (B) Large Allen Screw (1)
- (C) Spring Washer (1)
- (D) Metal Plate (1)
- (E) Lamp Base (1)
- (F) Lower Tube (1)
- (I) Upper Curved Tube (1)
- (L) Top Curved Tube (1)
- (M) Shade Cover (1)
- (N) Socket (1)
- (O) Metal Shade (1)
- (P) Shade Bracket (1)
- (Q) Socket Ring (1)
- (R) Hex Nut (1)
- (S) Plastic Washer (1)



Overarching Metal Shade Floor Lamp Assembly Instructions

Hardware Included:

- (A) Large Allen Key (1)
- (G) Medium Allen Key (1)
- (H) Medium Allen Screw (1)
- (J) Set screws (4) (includes one extra)
- (K) Small Allen Key (1)

A		1X	G		1X
B		1X	H		1X
C		1X	J		4X
D		1X	K		1X

To Assemble:

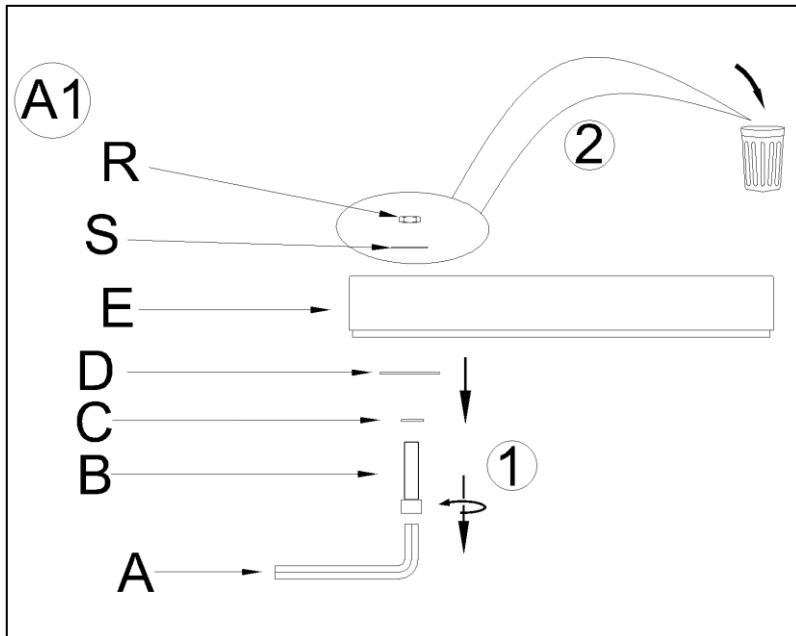

1. Loosen the Large Allen Screw (B) from Lamp Base (E) using Large Allen Key (A).
2. Discard the Plastic Washer (S) and Hex Nut (R).

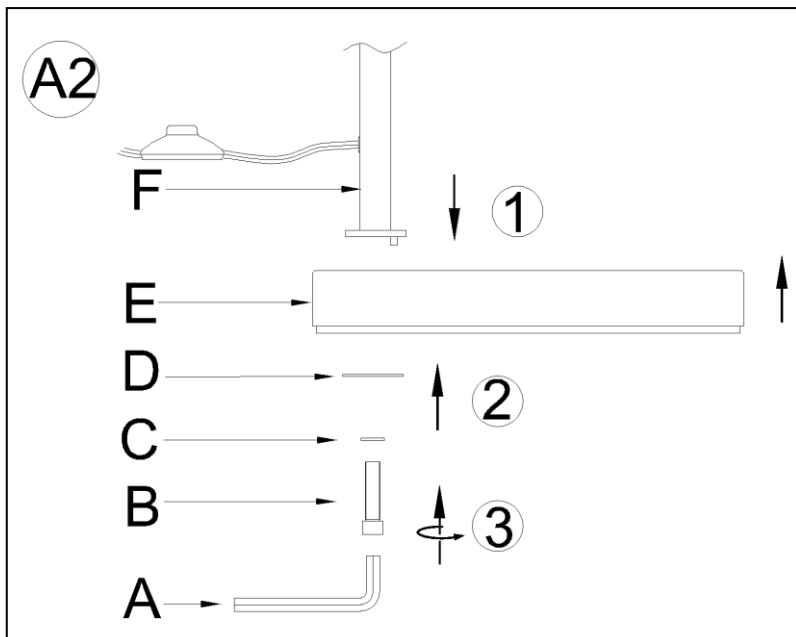

1. Attach the Lower Tube (F) onto the Lamp Base (E).
2. Insert the Allen Screw (B) with Spring Washer (C) and Metal Plate (D) into the bottom threaded hole of the Lamp Base (E) and Lower Tube (F).
3. Rotate the Allen Screw (B) clockwise using Large Allen Key (A) until tight.

Overarching Metal Shade Floor Lamp Assembly Instructions

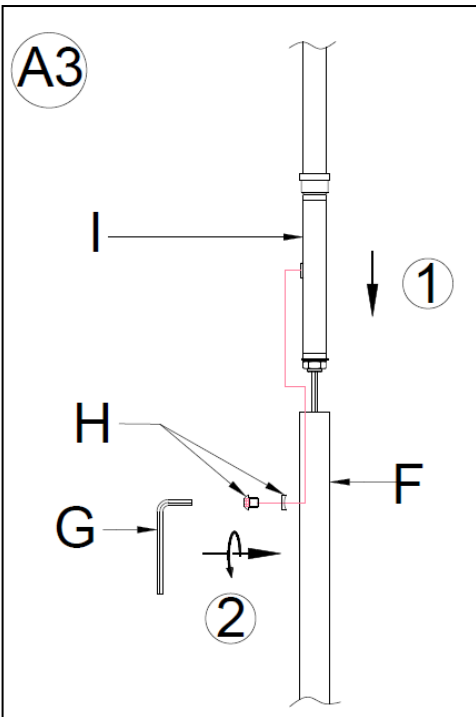

1. Insert the Upper Curved Tube (I) into the Lower Tube (F).
2. Secure the Medium Allen Screw (H) onto the drilled hole on Lower Tube (F) using Medium Allen Key (G) until tight.

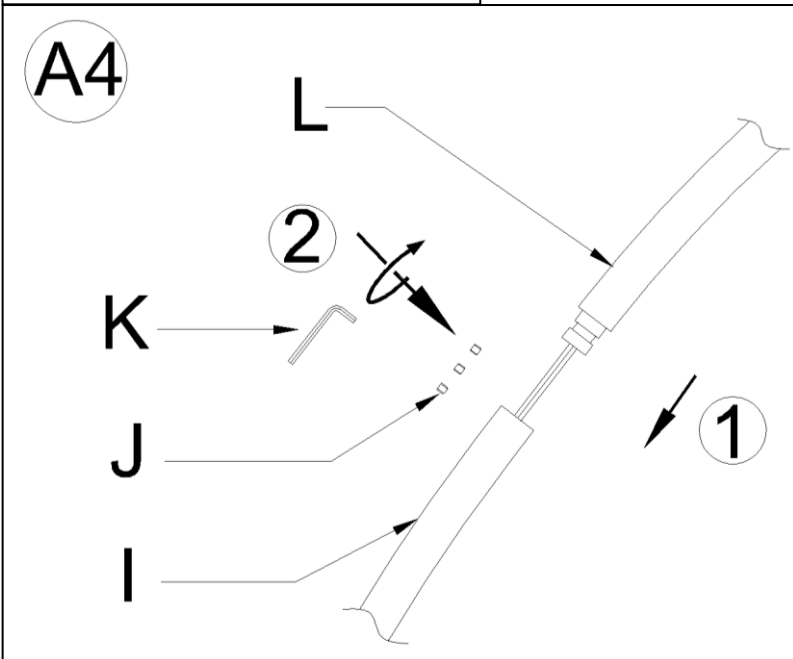

1. Insert the Top Curved Tube (L) into the Upper Curved Tube (I).
2. Secure the Set Screws (J) onto the drilled holes on Upper Curved Tube (I) using Small Allen Key (K) until tight.

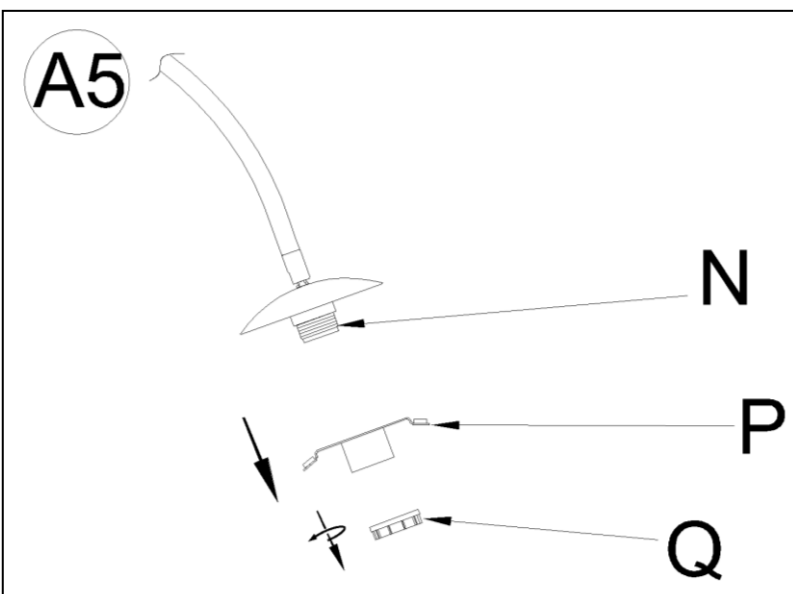

Remove Socket Ring (Q) and Shade Bracket (P) from Socket (N).

Overarching Metal Shade Floor Lamp Assembly Instructions

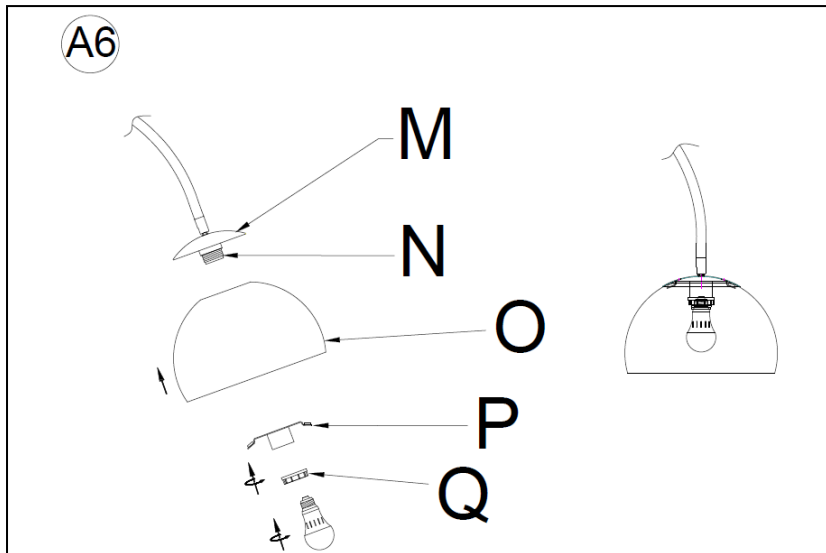

1. Attach the Metal Shade (O) onto the Shade Cover (M).
2. Insert the Shade Bracket (P) onto the Socket (N) and secure the Metal Shade (O) by tightening the Socket Ring (Q).
3. Insert the specified light bulb into the Socket (N).
DO NOT EXCEED THE SPECIFIED WATTAGE.

Care instructions:

- Wipe clean with a soft, dry cloth or static duster.
- Always avoid the use of harsh chemicals or abrasive cleaners as they may cause damage to the fixture's finish.

Thank you for your purchase
Stores | catalog | www.westelm.com
USA 888-922-4119